



ARIES SPAS

BY ARIES ACRYLIC MFG., INC.



OWNER'S MANUAL



ARIES SPAS

BY ARIES ACRYLIC MANUFACTURING, INC.

4176 I-30 EAST

ROCKWALL, TEXAS 75087

ARIES SPAS

OWNER'S MANUAL

Copyright © 2001 Aries Acrylic Mfg., Inc.
4176 I-30 East
Rockwall, Texas 75087 • (972) 771-6286

Printed in the USA

IMPORTANT SAFETY INSTRUCTIONS

READ AND FOLLOW ALL INSTRUCTIONS

- **WARNING** - To reduce the risk of injury, do not permit children to use this product unless they are closely supervised at all times.
- A wire connector is provided on this unit to connect a minimum No. 8 AWG (8.4mm²) solid copper conductor between this unit and any metal equipment, metal enclosures of electrical equipment, metal water pipe, or conduit within 5 feet (1.5 m) of the unit.
- **WARNING** - This product is provided with a ground-fault circuit-interrupter on the side of the control box (beneath the spa). The GFCI must be tested before each use. With the product operating, open the service door. If the product stops operating, this merely indicates that the door is equipped with an electrical interlock. Next, push the test button on the GFCI and close the service door. The product should not operate. Now, open the service door, push the reset button on the GFCI and close the service door. The product should now operate normally. If the product fails to operate in this manner, there is a ground current flowing indicating the possibility of an electric shock. Disconnect the power until the fault has been identified and corrected.

- **DANGER - Risk of Accidental Drowning.** Extreme caution must be exercised to prevent unauthorized access by children. To avoid accidents, ensure that children cannot use this spa unless they are supervised at all times.

 - **DANGER - Risk of injury.** The suction fittings in this spa are sized to match the specific water flow created by the pump. Should the need arise to replace the suction fittings or the pump, be sure that the flow rates are compatible.

 - **DANGER - Risk of Electric Shock.** Install at least 5 feet (1.5 m) from all metal surfaces. As an alternative, a spa may be installed within 5 feet of metal surfaces if each metal surface is permanently connected by a minimum No. 8 AWG (8.4 mm²) solid copper conductor to the wire connector on the terminal box that is provided for this purpose.

 - **DANGER - Risk of Electric Shock.** Do not permit any electric appliance, such as a light, telephone, radio, television, within 5 feet (1.5M) of a spa.

 - **WARNING - To reduce the risk of injury:**
 - The water in the spa should never exceed 40° C (104° F). Water temperatures between 38° C (100° F) and 40° C are considered safe for a healthy adult. Lower water temperatures are recommended for young children and when spa use exceeds 10 minutes.
-

- Since excessive water temperatures have a high potential for causing fetal damage during the early months of pregnancy, pregnant or possibly pregnant women shouldn't limit spa water temperatures to 38° C (100° F).
- Before entering a spa, the user should measure the water temperature with an accurate thermometer since the tolerance of water temperature-regulating devices varies.
- The use of alcohol, drugs, or medication before or during spa use may lead to unconsciousness with the possibility of drowning.
- Persons suffering from obesity or with a medical history of heart disease, low or high blood pressure, circulatory system problems, or diabetes should consult a physician before using a spa.
- Persons using medication should consult a physician before using a spa since some medications may affect heart rate, blood pressure, and circulation.

SAVE THESE INSTRUCTIONS.

About this manual

This booklet was designed to be an aid in understanding the operation, functions, and maintenance of your Aries Spa.

To receive maximum pleasure from your Aries Spa, it is helpful to understand how the spa operates and to have knowledge of proper maintenance procedures.

Different applications and installations require various types of equipment. If your equipment is different from that described in this manual, it may be necessary to refer to any manuals supplied by your equipment manufacturer for specific operating and installation information.

We hope that this manual will give you all the information needed to understand the basics of operation and maintenance of your spa. If you have questions that were not answered in this booklet, please give us a call.

Enjoy,
The staff at Aries Spas

Contents

Important Safety Instructions	ii
About this manual	v
Installation	1
Electrical Hookup.....	1
Replacement of Controls	2
Location.....	2
Operation	3
Initial Start-up	3
Filling your Spa	3
Starting your Circulating Pump	3
Equipment Pack.....	5
Power Switch (GFCI).....	5
GFCI Breaker “Test” and “Reset” Buttons.....	5
Spa-Side Controls.....	6
Digital Temperature Readout	7
Increase / Decrease Arrows.....	7
Function Buttons.....	7
Air Button	7
Light Button	8
Jet Button	8
L.E.D Indicator Lights	8
Set Light.....	9
Jets Lights	9
Air Light.....	9
Heat Light	9
Special Features.....	9

L.E.D. Display Inversion.....	9
"Good Night" Function.....	10
Auto-Purge Cleansing.....	10
Internal Clock.....	10
24 Hour / 12 Hour Circulation Mode.....	10
Freeze Protection.....	12
Internal High Limit Switch.....	12
Interior Fittings.....	12
Venturi Controls (Air Controls).....	12
Circulation Fittings.....	13
Suction Fittings.....	14
Hydrotherapy / Massage Jets.....	14
Standard Jets.....	15
Circular Jets.....	15
RotoJet.....	16
Neck Jets.....	16
Circulation & Recovery Jets.....	17
Air Injectors.....	18
Maintenance.....	18
Filter.....	18
Cleaning Your Filter.....	18
Water Treatment.....	21
Disinfectants.....	21
Bromine Products.....	21
Ozone Generator.....	22
Adjusting pH.....	22
Preventing Hard Water or Stain Damage.....	23
Preventing Algae.....	23
Caring For Your Spa's Surface.....	24

Deep-Cleaning of Plumbing Lines.....	24
Draining Your Spa	25
Troubleshooting Guide	26
Appendix A - Electrical Connections.....	33
Electrical Diagram for Electronic Controls	33
Electrical Connections for Electronic Controls	33

Installation of Portable Spa

HAVE YOUR ELECTRICIAN READ BEFORE INSTALLATION BEGINS!

(See appendix A for wiring diagram)

Please contact a qualified electrician to wire your spa.

All Aries Spas have a High current GFCI (ground-fault current interrupter) built in. A standard circuit breaker is required in your circuit supply panel. *Do not use a GFCI-type breaker in your supply panel.*

All Aries Spas require a 220 volt supply circuit consisting of four wires. Use #6 AWG wire (copper conductors only).

All metal components of the equipment assembly have bonding lugs. These lugs should be connected together with a minimum #6 AWG copper conductor.

All spa equipment packs require a dedicated breaker. The breaker should be 50 amp, (60 amp for double-jet pump system) single phase, 220 volt service, consisting of four wires; two hot wires, a neutral wire and a ground wire. Wire size is determined by length of run, but generally #8 wire for 0-50 feet and #6 wire for 51+ feet is recommended. This might vary, depending on length of run or other unforeseen factors. **Any variation from this service will void warranty.**

The control enclosure should be installed such that the heater housing is in a level, horizontal position and the bottom of the enclosure is approximately four inches above ground level.

All Aries Spas are designed to be permanently connected units, consisting of pumps, heater, light fixture and Spa-Side Control.

It is the responsibility of the spa owner to insure that electrical connections are made by a qualified electrician in accordance with the National Electric Code and any local and State Electrical Codes in force at the time of installation. These connections must be made in accordance with the wiring diagrams found inside the control box and the wiring diagrams within this manual. This equipment has been designed to operate on 60 Hz alternating current only and at 240 Volts. Make sure that power is not applied while performing any electrical installation. A copper bonding lug has been provided on the electrical equipment pack to allow connection to local grounded points. The ground wire must be at least 8 gauge solid copper and must be connected securely to a grounded metal structure.

Replacement of an existing control

Follow the instructions above for the control installation so that the proper settings are made for current and voltage that the spa was connected to. The replacement electronic control was shipped with the temperature sensor mounted in the heater housing and does not require the connection of the temperature sensor mounted in the spa.

Location

It is very important that your spa be located on a solid, level foundation.

A filled spa is very heavy (up to 5000 lbs.), with most of the weight resting on the center portion. Without firm support for the bottom of the spa, settling can occur, causing the outside edge or “lip” of the spa to carry the weight-load, pulling the spa out of shape. *Cement blocks are not acceptable, unless they are concreted into place.*

A 4" thick concrete pad is the desired foundation. If a balcony or deck is use, they must support at least 75 pounds per square foot.

Aries Spas will not be responsible for damages incurred on spas placed on other than level, solid surfaces.

If your spa is located near water sprinklers, adjust or relocate them so that water will not hit the siding of the spa.

Gates giving access to the spa should be self-closing and self-locking for safety.

Operation

Initial Start-up

Please read this section fully before attempting initial start-up of your spa.

Always turn the thermostat(s) and electric power off when filling or draining the spa, and always fully open any valves that could restrict water flow to and from the heater element.

Filling your Spa

Your spa should be filled with water to approximately the bottom slit in the skimmer (to identify, see picture of skimmer in the “Suctions Fittings” section of this manual). The water level should never be below the regular or whirling jets, but should never cover any neck jets, the recovery jet (see “Jets” section for picture) or built -in pillows. *Do not overfill spa.*

Starting your Circulating Pump

Turn on your home circuit breaker and service disconnect (if applicable). Push the red “reset” button on the GFCI, located on the right side of the black equipment box. Within 5 seconds, the continuous running circulation pump should come on and start moving water.

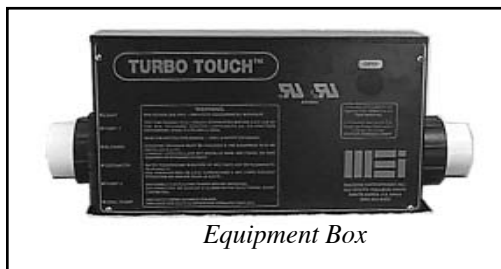

If, within a few seconds, water is not observed flowing from Return Jets (see “Jets” section for description), lift the acrylic lid that covers your Top Loading Pressure Filter, and

release any trapped air by turning the Bleed Valve (the small valve located on the filter lid) counterclockwise until you hear a release of air. *Do not totally unscrew or remove the Bleed Valve. Do not remove the black locking ring of the filter lid at this time or serious damage could occur.*

Opening the Bleed Valve will allow any trapped air to be purged and some gurgling or bubbles may come from the Return Jets. Once a steady stream of water starts spurting from the Bleed Valve, retighten by turning in a clockwise direction until hand-tight. (For more information on the Bleed Valve, see the “Top Loading Pressure Filter” section of this manual.)

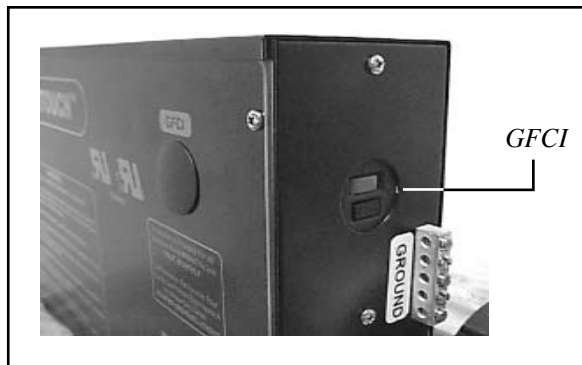

Once the Circulating Pump motor is running and water is circulating properly, you should be able to observe water and/or bubbles coming from the two Circulation Jets (one regular-sized, one small) usually located near your steps and/or the light. This indicates that the water is circulating properly.

If no water flow is observed, do the following:

1. Listen to make sure that the Circulating Pump motor is running.
2. Make sure that the Knife (“T” shaped) Valves are open. These valves are located on either side of the black control box. They are opened if the handles are extended as far out as they will go. When opened, you should be able to see either the exposed silver rod or a red retainer clip.
3. Recheck the Bleed Valve on the filter lid to make sure you have

released all trapped air. Sometimes draining a small amount of water from the Hose Bib (located by the Equipment Pack) is also helpful for releasing an air lock.

If you have tried all the above, and there is still no visible water flow coming from the Circulation Jets, **STOP!** Push the black “Test” button on the GFCI to turn spa off and call the Aries Spas Factory immediately! Do not go on to the next step or serious damage may occur to your spa equipment pack.

Once you are sure that the Circulating Pump motor is circulating the water, proceed to the next section.

Controls

Power Switch (GFCI)

Your Aries Spa Equipment Pack is provided with a ground-fault circuit interrupter (GFCI). This GFCI may look and/or operate similar to one you may have in your home, but know that it is a highly specialized device exclusive to your Aries Spa. It is located on the right side of the Equipment Pack (not on the face of the equipment pack). Electrical problems within the spa equipment are monitored by this device. If any potential shock situation does occur, this device will interrupt the power supply, thereby removing the potential of danger to equipment and/or human occupants.

You can use this GFCI as a system “On-Off” switch.

GFCI Breaker (Test) and (Reset) Buttons

To make sure that the GFCI breaker is operating properly, press the black button labeled “Test”. If operating normally, the Equipment Pack will shut off, and the black button will pop out and require resetting. The same will happen if water comes into contact with the components.

To reset, push the red “Reset” button. If the equipment has been wet, and the black button immediately pops out again, wait a sufficient amount of

time for all moisture to evaporate, and try to reset again. If it continues to pop out, call your spa dealer or Aries Factory.

Spa-Side Controls

Your Aries Spa equipment is composed of state-of-the-art microprocessor circuitry, similar to that of a home computer. All user-functions and operational changes are done via the Top Side spa control.

Setting the Desired Temperature

The Thermostat can be set to temperatures within a range from 80° through 106° as described below. If you try to adjust lower than 80°, the display will cycle back to the highest degree, 106°. If you try to adjust above 106°, the display will circle back to 80°.

Use the digital readout and your personal preferences as a guide in adjusting the thermostat.

IMPORTANT: At no time should the temperature be set or left at 81°. This is a programming setting, and you could

unintentionally permanently alter the operational system. Permanent damage to internal programming can occur and will not be warranted.

WARNING: Prolonged immersion in hot water may induce hyperthermia. The causes, symptoms and effects of hyperthermia may be described as follows: Hyperthermia occurs when the internal temperature of the body reaches a level several degrees above the normal body temperature of 37°C (98.6°F). The symptoms of hyperthermia include drowsiness, lethargy and an increase in the internal



Spa-Side Controls

temperature of the body. The effects of hyperthermia include:

- ◇ *Unawareness of impending hazard*
- ◇ *Failure to perceive heat*
- ◇ *Failure to recognize the need to exit the spa*
- ◇ *Physical inability to exit the spa*
- ◇ *Fetal damage in pregnant women*
- ◇ *Unconsciousness and danger of drowning*

WARNING - The use of alcohol, drugs or medication can greatly increase the risk of fatal hyperthermia.

Digital Temperature Readout / Adjustment Readout

The Spa-Side Control has a digital readout of the spa's water temperature. (It is not uncommon for the temperature shown to vary from the actual water temperature by a few degrees.) This readout also displays the desired temperature as you reset (see below).

Increase (Up) and Decrease (Down) Arrows

To increase the water temperature, push the “up arrow” button (shaped like a triangle). To decrease the temperature, push the “down arrow” button. As you make adjustments, the digital temperature readout, which previously showed the actual water temperature, will temporarily show the "desired temperature" you are adjusting to. Once the desired temperature is displayed, release the adjustment arrow.

Function Buttons

“Air” Button

This button operates the Air Blower Pump. It forces air through the Air Injectors (fittings in the spa seats that introduce air into the spa under pressure. They resemble saltshaker tops). Push the air button and the Air Blower will come on. Push it again and the Blower will shut off. If the Air Blower is turned on and left running, it will automatically turn off after 30 minutes.

For more information, please refer to "Air Injector Fittings" section in

this manual.

"Light" Button

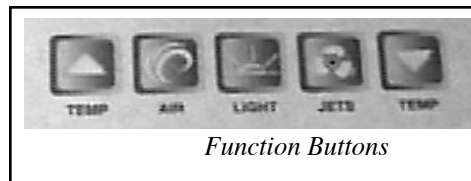

This button operates the Spa Light, which is usually located in the step area of your spa. Push the button once and the light will turn on. Push it again and the light will turn off.

A special "Good Night" function of the "Light" Button turns off all Jet and Blower pumps when the light is turned off. This allows the user to leave the spa for the evening without having to turn off several components.

"Jets" Button

This button operates all the different types of hydrotherapy massage jets in your spa. Press the button and the Jet Pump will turn on. Press again and the Jet Pump will turn off.

On spas equipped with 2 Jet Pumps, each press of the button puts the spa through one step of the following cycle:

- 1) Jet Pump A turns on
- 2) Jet Pump B turns on (both pumps are now running)
- 3) Jet Pump A turns off (Jet Pump B will still be running)
- 4) Both Pumps turn off

If left running, the Jet Pump will turn off automatically after 30 minutes.

L.E.D. Indicator Lights

There are several Indicator Lights on your Spa-side Control. They will light at certain times, as described below:

"Set" Indicator Light

As you adjust to your desired temperature settings using the adjustment arrows, the "Set" light will illuminate. A few seconds after releasing the arrows, the "SET" light will go off and the digital readout will again show the actual water temperature.

"Jets B" Light

This light will illuminate when the second Jet Pump is activated. (This applies only to spas equipped with two Jet Pumps.)

"Jets A" Light

This light will illuminate when the Jet Pump is activated. (This applies to all Aries Spas.)

"Air" Light

This light will illuminate when the Air Blower Pump is activated.

"Heat" Light

This light will illuminate any time the heater is operating. When the water reaches the desired temperature previously set, this light goes out.

An exception to this is if the spa is operating in the optional 12 hour operational mode (described later). In this mode, the light may be on, but the heater is not heating the water because the Circulating Pump is not moving any water through the heater. (By design)

Special Features

LED Display Inversion

This feature allows the temperature to read right-side-facing when looking at it from inside the spa. Normally, the temperature display reads right-side-facing when viewing from outside the spa.

To invert the display, press and hold the light button, then press the temperature up arrow. Release the light button. The display is now inverted.

To change back, perform this procedure again.

"Good Night" Function

After you have used the spa, you may turn off the spa light by depressing the "Light" Button and turn off all the Jet and Air Blower Pumps simultaneously. If you didn't have the spa light on and want to use this feature, simply push the "Light" Button once to turn on light, then push it again to shut off the light, and all Jet and Blower Pumps simultaneously.

Auto-Purge Cleansing

Your Aries Spa is equipped with an Auto-Purge System that automatically turns on all pumps for a few seconds each day. This daily flushing of lines is important to the overall sanitization of the water, eliminating stagnant water in unused jet lines.

This is an automatic feature and takes no effort on your part. It takes place daily at the moment the internal clock was last reset (see below).

Internal Clock

In the effort to improve and simplify the operations of spas, we have eliminated the traditional hard-to-set timeclock and replaced it with a much simpler-to-use design.

Start time of the clock is mostly insignificant except for the auto-purge or 12 hour circulation modes. The start time is reset every time the power is reset after being turned off, regardless of method of disconnect. When changing from the 24 hour to 12 hour circulation mode, the clock is reset at the time you initiate the change.

24 Hour / 12 Hour Circulation Modes

Aries recommends leaving the Circulation Mode set in 24 Hour Mode, except during severely hot weather conditions. In areas that have hot summer temperatures, heat can accumulate in the spa water. Sunlight and hot ambient air temperatures can send spa water temperatures soaring. To

combat this problem a special 12 Hour Circulation Mode is available.

Warning: Never use the 12 Hour Mode in Wintertime or when freezing weather could occur. This disables the Freeze Protection and could cause water in your equipment or lines to freeze, causing serious damage. Aries will not warranty against freeze damage caused when spa has been left in the 12 Hour Mode.

To convert from 24 hour operation to 12 hour operation of the Circulation, push the “Light” button and while depressing it, push the “Jets” button. “24H” will appear in the LED area of the topside. This stands for 24 hour or continuous running of the Circulation system. (This is the mode the spa is set in when it leaves the factory and it should remain this way at all times unless an excessive heat buildup occurs.) Release the “Light” button and immediately push the “Jets” button again. “12H” should now appear in the LED screen. After 5 seconds the “SET” light will go off and the circulation pump will shut down. To return to the 24 Hour Mode, use the same method described above, until "24H" is displayed.

Initially, after setting to the 12 Hour Mode, the Circulation Pump will stay off for 24 hours. Then the Circulating Pump will come on and run for 12 hours, then shut off for 12 hours. This will repeat until the mode is changed back to 24 Hour Mode.

During the “off” period, jet and blower functions are still available to be used, but the heater will not operate.

It is recommended that when you initially set to the 12 Hour Mode that you do this in the late evening. This will cause the Pumps to start 24 hours later, and its running time will be during the night, in the cooler period.

Freeze Protection

In an Aries Continuous Circulating Spa, the potential for freeze dam-

age is almost nonexistent. With the addition of the Auto-Purge function, freeze damage is very rare and is most common with spas that have been drained for the winter.

Aries recommends never draining a spa or leaving a spa drained at any time of the year, especially for the winter. Regardless of draining procedures used, there will always be a small amount of water remaining in the plumbing lines. In wintertime, this water can freeze and expand, causing serious damage to your plumbing and equipment systems. Aries Spas does not warranty freeze-damage done to spas left drained.

Internal High Limit Switch

Your spa equipment pack is equipped with a heater overheat sensor. This sensor protects your heater by turning off power to the Equipment Pack in cases where the water temperature in the heater have reached a higher-than-normal condition. This can happen when your filter is clogged or dirty enough to slow the water flow and water is trapped in the heater for longer-than-normal periods of time.

If the Limit Switch trips, "HI" will be displayed on the temperature read-out on your Topside Control.

To reset, push the "Light" or "Jet" Button. If it will not reset, wait until the water inside the heater has had sufficient time to cool, then try again to reset. (Depending on the outside temperature, this could take up to several hours or overnight.)

Interior Fittings

Venturi Controls (Air Controls)

Venturi Controls are round knobs located on the "lip" or upper ledge of your spa. Depending on the model, your spa may have one or several Venturi Controls, each operating a certain number of jets. They control the amount of air that is mixed with the water coming through the jets.

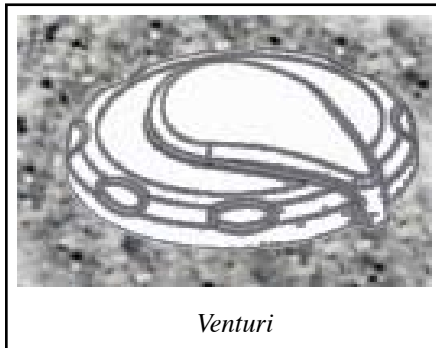

To control the amount of air introduced into your jets, turn the Venturi Control to the desired setting, to any position from far counterclockwise (maximum on) to far clockwise (minimum off). For maximum air injection and a firmer massage, turn the knob all the way counterclockwise. For a more gentle massage, turn toward clockwise.

When the jet pump is not running, the venturis will do nothing. It does not matter what position they are left in when you leave the spa.

Circulation Fittings

All of the fittings under the water in your spa are considered circulation fittings. They either circulate air or water. Your spa has two types of water fittings; suction and return. Some are designed to move water from the spa to the equipment (suction fittings), while others move water from the equipment to the spa (return fittings).

The spa's Circulating Pump circulates your spa's water by pulling it from the spa via Suction Fittings (the Top Suction or Skimmer, and the Bottom Suctions), passing it through the heater and filter, then returning it to the spa via the Circulation Jets, usually located near the light or step of the spa. Normally, there are two Circulation Jets: one is a normal-sized jet, the other is a very small, white jet.

The spa's Jet Pump circulates water by pulling it from the spa via separate Bottom Suction Fitting and returns the water through the Massage Jets.

Suction Fittings

The Top Suction, or Skimmer, is designed to skim debris from the water's surface. The Bottom Suctions are designed to pull water and dirt from near the spa's bottom. The Suctions draw water from the spa when-

ever the Circulating Pump is running.

It is important that the perforated cover of the suction always be in place and in good condition.

If it is damaged or broken, it must be replaced immediately. Dangerous conditions may occur if the spa is operated with damaged or missing suction covers.

The Circulating Pump will draw water from one bottom suction and the skimmer. Because this pump is of a small energy efficient design, you will probably not feel water passing into the bottom suction fitting that is connected to this system.



Skimmer

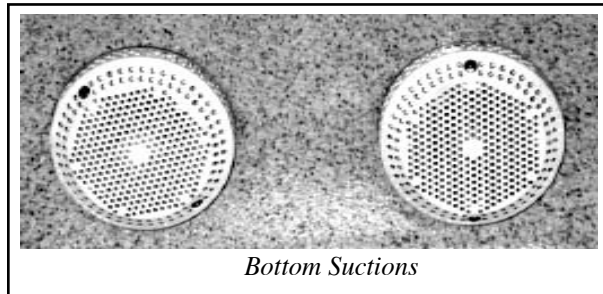

Bottom Suctions

Hydrotherapy / Massage Jets

The Massage Jets in your spa are powered by the high-speed Jet Pump. The water is drawn from your spa via a Bottom Suction, and returned through your Massage Jets.

These jets massage sore muscles and stimulate and increase blood circulation to aid in the recovery of injured body parts. Most spa owners agree that this is the single most beneficial function of their spa.

Below are the description and operation of several of the more popular Massage Jets available at press time. In our continuing effort to update and improve the quality of our product, and because of the rapid advancements in the components available to us, jet availability changes frequent-

ly. Because of this, the jets described below may not be identical with those being used at the time of your spa's manufacture.

Standard Jets

You can adjust both the direction and the velocity of water flow from the Standard Jets. The water flow can be reduced by turning the center nozzle or outer ring (depending on the model) clockwise. By closing one jet, the pressure in the other jets is increased.

Do not close more than four jets at one time. Doing so can damage the plumbing system of your spa.

You can adjust the flow from the jet by aiming the nozzle in the desired direction.



Circular Jets

There are several versions of these jets but they are all distinguished by their circular flow of water. Some allow you to adjust the diameter of the flow pattern. Certain designs have two circles that overlap each other when operating.

One model has an exterior that looks like a “honeycomb” and has a circular jet behind the “honeycomb” baffles. The water can only escape at the individual holes thereby creating a pulsing circular effect.



RotoJet

The RotoJet is optional, and is not available on all models.

The RotoJet is the big brother of the Circular Jet, and is the largest jet you will have in your spa. It uses a large volume of water for a deep-muscle massage.

The RotoJet's nozzle can be adjusted to three different positions to increase or decrease the diameter of the circular pattern. For the smallest diameter flow, push the center nozzle into the center position of the slot in which it rests. For a larger diameter flow, push toward either side of the slot. For the largest flow, push nozzle as far as it will go to either side of the slot.

Also, the water pressure can be adjusted by turning the outer ring of the jet clockwise (to decrease pressure) or counterclockwise (to increase pressure).

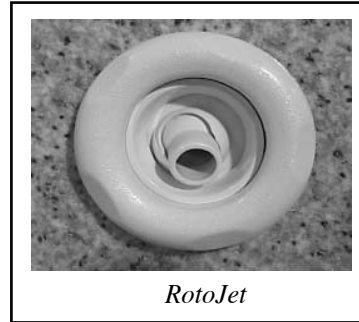

Neck Jets

Neck Jets are normally found above the water level. They can be turned on or off by pushing the nozzle inward (off) or pulling it outward (on). It is best to leave the Neck Jets off while not in use, because they sometime inject the water above the normal water level of the spa, splashing it out.

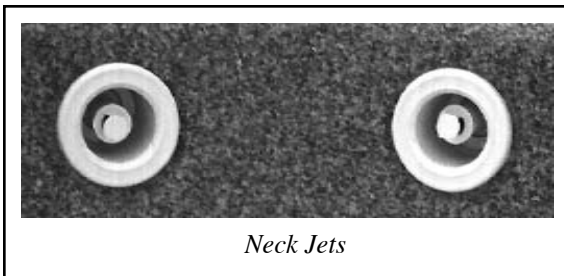

These jets are designed to be above the waterline and should not be covered by water.

*Circulation & Recovery Jets
Do not obstruct the flow of these jets or serious damage could occur.*

The Circulation Jets are two

jets, usually located near the light and/or interior spa steps. One is a regular-sized jet, the other a very small jet. After the water is circulated through your Circulating Pump, it is returned to the spa via these two jets.

If your spa is equipped with an Ozone Generator (described later in this manual), the air bubbles coming from these jets contains the cleansing agent produced by the Ozone Generator. If not equipped with an Ozone Generator, the bubbles are merely air. If your spa does not presently have an Ozone Generator, one can be added at a later time.

The Recovery Jet is a small jet above the spa water level. It looks the same as the small Circulation Jet. This jet is designed to draw air from the space between your spa water and the spa cover. If your spa is equipped with an Ozone Generator, this air is charged with the cleansing agent produced by the Ozone Generator. The air and cleansing agent are reintroduced into your spa's water, to efficiently get the maximum cleansing effect possible.

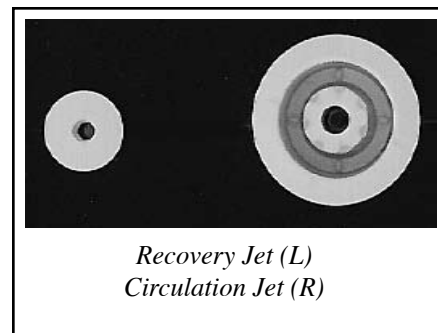

If your spa is not equipped with an Ozone Generator, this fitting does nothing. It is there to facilitate the addition of an Ozone Generator if one is desired at a later date.

Occasionally, jets that look similar to the small Circulation Jets will be used in place of Neck Jets or Regular Jets in the spa. These jets are not attached to the Ozone Generator, but rather are similar to standard jets. The Circulation & Recovery Jets are not adjustable.

Air Injectors

Most Aries Spas contain 14 to 20 Air Injectors, depending on the model of spa. These are white or stainless steel fittings (normally resembling

salt shaker tops) located in the seating area of your spa. When you activate the Air Blower Pump by pressing the “Air” button on your Spa-side Control, air is forced through these fittings to make stimulating, tingly bubbles.

The source for this air is the inside the spa enclosure (cabinet). The air that passes through the blower absorbs some heat from the blower, but it is not uncommon for the air to feel cool, or colder than the spa water.

Maintenance

Filter

The most important function of the Circulating System is to run the spa water through the filter to remove dirt, debris, and body oils. The filter cartridge is located inside the filter canister, hidden by the round acrylic lid containing inset drink holders.

The Top Loading Pressure filter is most commonly used due to its ease of cleaning and maintenance. It is available in the majority of Aries Spa models.

Cleaning Your Filter

Cleaning of the filter is the single most important maintenance procedure that a new spa owner can perform.

Aries recommends that you clean your Filter at least once a week. If cared for properly, you can expect to get about 1 year's use from each Filter Cartridge, depending on spa usage. When the Cartridge becomes worn, damaged, or heavily debris-embedded, replace it with a new one.

Before cleaning the Filter, make sure to turn off power to the spa, using the GFCI. To do this, push the “test” or “off” button on your GFCI. Or, you can turn off power to the spa by turning off the breaker in your electrical panel that powers the spa. Once power to the spa has been terminated you may proceed to clean your Filter.

As the Top Loading filter is a pressure filter, make sure that power to spa is turned off before attempting to open this type of filter. Do not open the filter case while the Circulating Pump is operating or serious bodily injury could occur.

To locate the Filter Cartridge, remove the round acrylic cover located on the top “lip” of your spa. Underneath, you will see a dome-shaped plastic lid held in place with a “mason-jar” type retaining ring. *Before attempting to open this, make sure that you have turned off main power switch or GFCI.* Release any excess air in the Filter by turning the small plastic Bleed Valve on top of the lid. Then unscrew the retaining ring by turning counterclockwise. Once the retaining ring has been loosened, lift the ring and the Filter lid. Inside, you will find an accordion-folded fabric Cartridge. Firmly pull up on the Cartridge to remove it.

Spray the cartridge with high pressure water from your water hose. The use of a pressure gun or nozzle is recommended to ensure that the water cleanses between the accordion-like pleats of the filter. Start at the top working your way down, while rotating it around.

If it appears to be heavily embedded with body oil or debris, you can clean it in your dishwasher, as the very hot water helps to break down the body oils. **If you choose to use this method, do not add detergent, and make sure that the dishwasher's drying cycle is turned off.**

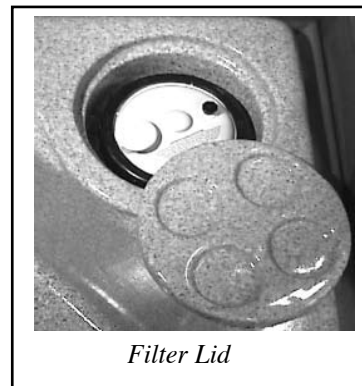

Note: For convenience sake, you may want to purchase an extra Filter Cartridge. When one needs cleaning, you can replace it with the other, and soak the dirty Cartridge in a mild solution of swimming pool acid (50 parts water to 1 part acid) or a 50/50 solution of household bleach,

overnight. Then let it dry and shake or brush lightly. This process helps to remove body oils and fine embedded particles, resulting in the cleanest-possible Cartridge with the least amount of effort. If you use this method, make sure to hose off the cartridge thoroughly (after soaking and brushing) to remove bleach or acid residue.

Before repositioning the Cartridge, examine it for any tears or other damage. If damage is detected, you will need to replace it.

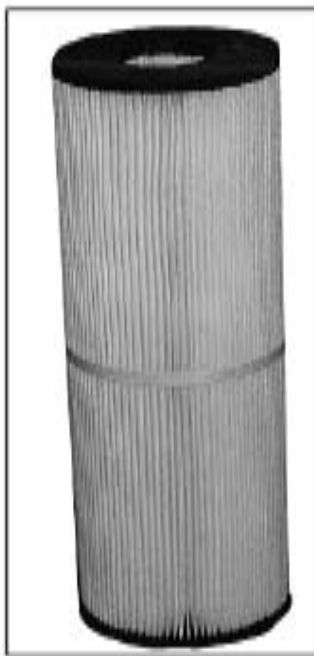

Filter Cartridge

Reposition the Cartridge in the filter canister by reversing the process you used to remove it. When you have completed reassembling the filter, reset the GFCI or otherwise turn on the spa. The Circulating Pump will come on immediately. You should see water starting to flow from the Return Jets and hear bubbling and gurgling. This is air being purged from the system. To remove any remaining air, momentarily turn counterclockwise the black Bleed Valve on top of the filter lid. When water starts to spray out, turn valve clockwise til closed.

Make sure that there are bubbles coming from the Circulating Jets. If not, refer to the “Initial Start-up” section of this manual. Once your Circulating Pump is operating properly, return Thermostat to previous setting.

Also, check to see that no water is leaking from around the “mason-jar” lid. If you detect any leaks, turn off the power and remove the lid again. With a small amount of Vaseline® or marine lubricant, lubricate the rubber gasket on the underside of the spa lid. Replace the lid as before and restart the Circulating Pump. If leaking persists, call Aries Service Department for assistance.

Water Treatment

One of the benefits of Aries' Continuous Circulating System is water treatment. If you are sanitizing with chemicals, this system will effectively stir water to aid in the mixture of chemicals and water. If your spa is ozone equipped, continuous injection of ozone will create a nearly chemical and maintenance-free spa.

Water treatment is a somewhat specialized topic. We will attempt to cover some of the basics, but we recommend visiting a spa chemical store, or the Aries Factory. Also, there are several good books available on the subject.

It is necessary to treat your spa's water for two important reasons:

1) To keep the spa water free from harmful bacteria and algae.

2) To keep the water's percentage of acidity and alkalinity (pH) in balance, so that your spa's equipment will not be corroded by acid or clogged by alkaline buildup.

Disinfectants

There are several alternatives for disinfecting your spa, including chemical disinfectants (most notably bromine or chlorine products), and non-chemical methods (such as ozone generators, reverse ionizers, etc.). Ask your spa specialist for a more detailed explanation.

The non-chemical methods will not only sanitize your water, but also help to stabilize the water's pH balance (explained below). This is because you aren't altering the balance by adding chemicals (which have a pH factor of their own).

Bromine

To chemically treat against bacteria, spa bromine is often used. Many brands come in self-dispensing containers. If you use these, check frequently to make sure that your dispenser hasn't run out of chemical. Also, using a spa test kit, test the water frequently to make sure that your

sanitizer is at acceptable levels.

The use of chlorine products are not recommended for acrylic spas, such as Aries Spas.

Occasionally, it is necessary to add a larger-than-ordinary quantity of disinfectant to remove body oils and protein wastes (such as perspiration) from the water. This large dose, or “Shock Treatment”, can be purchased in handy packets, or in bulk form.

Ozone Generator

Ozone Generation is a method of sanitizing water that has been in general use since the late 1800’s. Most of the bottled drinking water today is purified by ozone as part of the process. The Ozone Generator uses ultraviolet rays to purify the water.

Because this method of sanitizing uses much less chemicals, chemical residue in the spa water is lessened. Also, because you are not adding as many products with their own pH factor (see below), the pH of your spa water stays balanced longer.

When using an Ozone Generator for sanitizing, it is extremely important to operate the Circulating Pump for sufficient periods of time each day. We recommend operating the Circulating Pump continuously.

Adjusting pH

It is necessary to keep your spa water’s pH (acidity /alkalinity ratio) at acceptable levels. A simplified explanation of pH is that it is like a ruler, with numbers ranging from 1 to 14. The center of the ruler, 7, is neutral, meaning the degree of acid and the degree of alkaline are equal and they neutralize each other. The higher the number past 7, the more alkaline the water is. For example a reading of 7.5 shows barely alkaline water, while 9 has a great deal more alkalinity, etc. On the other hand, the lower

the number, the more acidic the water. The desired pH level of your spa's water is within the range of 7.2 to 7.8. Your test kit should have a pH test included.

After testing, if your pH level is too high, (the water is too alkaline) use one of the pH-lowering products found in many pool and spa stores. If this product is acid, it should be in powder or dry form. Use of liquid acid is not recommended. If the pH level is too low, (the water is too acidic), use one of the pH-raising products available at your local spa supply store. (You might try adding household baking soda to raise the pH if only slight adjustment is needed.) It is best to adjust pH gradually. Remember, it is easy to add, but difficult to remove chemicals from your water.

We do not recommend using chemicals formulated for swimming pools in your spa. These products are highly concentrated for use in large volumes of water (15,000 to 30,000 gals.). Proper dilution of these chemicals to an acceptable strength is difficult at best. Whenever possible, use one of the chemicals specifically formulated for spas. The Aries Factory carries a complete line of spa chemicals.

Preventing Hard Water or Staining Damage

In some instances, water from your city source or well is extremely hard or contains excessive minerals. There are several good products that can be added in maintenance doses to prevent staining or hard-water buildup. Check with your local pool and spa supply or Aries.

Preventing Algae

In some cases, if Ozone (if so equipped) or chemical levels temporarily fall, algae can begin to grow in your spa's piping. Once growing, normal levels of Ozone or chemicals are usually not sufficient to completely kill the roots of the algae. Spa algaecide is available at most pool and spa supply stores and at Aries. It can be used in maintenance doses to prevent

algae.

Caring for your Spa's Surface

To clean the acrylic surface of your spa, use a nonabrasive cleaner, such as Lysol Tub & Tile Cleaner®, Ivory Bathroom Cleaner®, etc. Make sure to rinse thoroughly before refilling. Otherwise, your spa will make soap-suds when you operate the spa. Keep fingernail polish remover, acetone, etc. away from the spa's surface.

Keep sharp instruments, such as nails or stones from coming into contact with the acrylic surface of your spa. If your spa's surface does become slightly scratched, Ineos (the maker of Lucite©) recommends applying a coat of auto wax on the scratch. For more serious scratches, it is suggested you carefully sand the scratch with 400 grit sandpaper. For scratches or chips that go completely through the acrylic surface, acrylic repair becomes necessary. There are repair kits available at most spa supply stores.

Deep-Cleaning of Plumbing Lines

Occasionally, spas that are not used for long periods of time will develop "white flaky stuff" floating on the surface. This "stuff" is usually algae and can be removed Algae Treatments or by draining and refilling. But sometimes a simple drain and refill of the spa is not enough. Occasionally, a deep-cleaning or flushing of the spa's internal plumbing system is necessary to remove buildup of algae growth.

To accomplish this, first turn the heater off by lowering the desired temperature. Add common bleach to the spa water; One gallon for 7' spas and two gallons for 8' spas. Run the Jet Pump and Air Blower Pump for 5 minutes. Then let the water sit for 20 minutes. Run jets and blower again. Let sit again. Repeat this several times as needed. Finally, drain the spa and refill with fresh water. Install a new filter cartridge. This is the best method for deep cleaning of the internal plumbing.

Draining your Spa

Occasionally, it may become necessary to drain your spa for thorough cleaning or other reasons. Aries recommends draining and refilling the water at least once a year.

Before draining your spa, turn off spa's Main Power Switch or GFCI. Otherwise serious damage to equipment may result.

Siphoning is the easiest method for draining your spa. Before siphoning, make sure that your pump is off and will remain off while the spa is draining or empty. (Do this by pushing the “Test” or “Off” button on your GFCI.) The easiest way to start a siphon is to leave your garden hose hooked to a water spigot, with the free end of the hose in your spa water. Turn on the faucet, as if to add water to your spa. As soon as water starts running into the spa, quickly turn off the water and unscrew the hose from the faucet. The water will automatically start siphoning out.

Note: The above method of starting a siphon only works when the faucet is below the water level of the spa.

Another way of emptying your spa is to use the faucet or spigot attached to the equipment pack. Open the valve (turn the spigot). It is best if you attach a garden hose to the faucet, keeping the water off of the Equipment Pack. The water will start to drain out as long as the free end of the hose is below the water level of the spa.

Note: The above method will drain the water only to the level of the lowest circulating fitting in the spa (the lowest Bottom Suction). The remaining water will have to be siphoned (as described above) or bailed out.

Troubleshooting Guide

Problem	Possible Causes/Solutions
---------	---------------------------

Spa Equipment does not operate. Nothing works.

GFCI has possibly tripped or may be turned off.

Reset GFCI on spa pack by pushing "On". If GFCI resets for a moment, then trips again, see "Blower does not work" below.

Household circuit breaker has tripped.

Switch breaker to "Off" position, then reset to "On".

Equipment is not wired correctly, or isn't provided with proper power.

Refer to wiring directions in your equipment manual. If you have questions, call your spa dealer or the factory.

Can hear Circulating Pump running, but water is not circulating.

Knife valve(s) closed.

Shut off spa immediately. Otherwise, your equipment will "dry-fire" and burn out. Make sure all knife valves are in open position (pulled up). If they are fully down, they must be turned one-half turn before pulling open.

Circulating Pump has drawn air and lost prime.

Make sure that the water level in the spa is approximately to the top slit of the Skimmer. Turn Thermostat to the lowest setting to protect heater. To release air from the system, with pump running, loosen (but do not remove) Bleed Valve located on the Filter lid. (This is a small screwlike fitting on top of the Pressure Filter.) Wait until water starts to spurt from the Bleed Valve, then re-close.

Let pump run for about ten minutes. If prime has not been restored, momentarily turn open the hose bib drain and allow some water to run out. You may need to do this several times to purge all trapped air.

Don't let the pump run for more than ten minutes without prime. To do so could cause serious damage to your equipment. If, after 10 minutes, your pump has not picked up prime, wait 1 hour and try again to restore prime. If you still can't start circulation, then call Aries Service Department for additional tips.

After prime has been restored, reset Thermostat to desired temperature setting.

The Filter Cartridge is very dirty.

A clogged Filter Cartridge may not allow water to pass through to the spa. To verify whether this is your problem, remove the Filter Cartridge, and reseal your filter without the Cartridge inside. If the water now circulates properly, clean your Filter Cartridge thoroughly, as explained in "Cleaning your filter". If, after cleaning, it still restricts circulation, it has probably become heavily embedded with debris and oil. It will be necessary to replace the Cartridge.

Spa does not heat

The Filter Cartridge is dirty, causing insufficient water flow.

When your heater's interior flow valve senses low water flow (this can be caused by a clogged Filter Cartridge), it shuts the heater off until the flow is again sufficient (protecting your heater from overheating, and possibly burning out). Thoroughly clean your Filter Cartridge and restart the equipment.

The Knife ("T" shaped) Valves may be partially or fully closed, causing insufficient water flow (see "Filter Cartridge is dirty" above).

Make sure that all Knife Valves on either side of the Equipment Pack are completely open ("T" pulled fully outward), and restart spa.

Water level in spa is below normal operating level, causing insufficient water flow to heater (see "Filter Cartridge is dirty" above).

Fill spa to appropriate level (to about the top slit of Skimmer) and restart.

Internal "High Limit" switch may be tripped.

If the water temperature in the heater tube gets too hot (106° spa water), the high limit switch will trip and turn off the heater to protect the spa equipment from overheating. If this occurs, the word "HI" will be displayed in the LED readout area of the Topside Control. To reset, push the "Light" or "Jets" Button.

It may take several hours (or overnight, in warm weather) for the temperature to fall low enough for the High Limit to be reset. (A clogged, dirty Filter Cartridge can cause High Limit Switch to trip.)

Spa water is too warm and won't cool off

You've heated the water too warm, and the outside temperature is hot, not letting the water cool .

Turn down the Thermostat, and add cool water to your spa. If the outside temperature is very hot, you might try adding some ice, also. This will help speed the process of cooling the water.

Jet Pump does not work

There is an air lock inside the Jet Pump system (this is a common problem in in-deck installations, especially after spa has been drained and refilled).

After turning system off, locate the Quick Coupler (it is black and has ridges to aid in gripping) closest to the pump that is not operating. Loosen it by turning counterclockwise until water starts flowing out. Retighten and try to operate the system again.

Can hear Jet Pump running, but water is not circulating

All jets are partially or fully closed.

Shut off spa immediately, otherwise your jet pump may overheat and possibly burn out. Make sure to open 3 jets at least 75%. Open by turning their outer ring counterclockwise.

Knife Valves are partially or fully closed.

Shut off spa immediately, otherwise your Jet Pump may overheat and possibly burn out. Make sure to open all Knife Valves completely. If they are locked, rotate the handle one-half turn and then pull up.

One of the Bottom Suction Fittings in the footwell area isn't working

The suction is a suction for the circulating pump

Your spa should have 3 or more Bottom Suctions. One of these is used to return water to the Circulating Pump, the others return water to the Jet Pumps. The Jet Pumps are large pumps that move a great deal of water and the pull from their suction is very noticeable. The Circulating Pump is very small (for energy efficiency) and moves water at a much slower pace. You will not be able to see or feel the pull of its bottom suction, but will be able to see the water returning to the spa via the Circulation & Recovery Jets

The Top Skimmer is not drawing everything in

This is normal and takes no action on your part.

Your spa's Circulating Pump moves small volumes of water over long periods of time for efficiency. Eventually, the surface items are drawn into the filter.

Nothing works except Air Blower Pump and Light

The system has been incorrectly wired and is only receiving 110 power, instead of 220.

Call your electrician, or call Aries Service Department for proper wiring instructions.

Air Blower does not work

Air Blower Pump's automatic shut-off feature has kicked in.

The pump is designed to automatically shut off after 30 minute run time to prevent overheating if user should forget to turn off. Wait a minute, then turn reactivate blower.

Air Blower Pump's Internal High Limit has been tripped.

The pump has become overheated. The internal switch will reset itself after the unit has cooled sufficiently. Wait 20 minutes or so and try to turn on again.

When Air Blower is turned on, all equipment shuts off and won't restart

Air Blower has gotten wet.

The GFCI breaker has tripped because of moisture. The most common causes are:

- 1) overfilling of the spa (or large bather load) causing water to overflow the P-trap.
- 2) Large amounts of humidity or rain, runoff from sprinklers, etc.

To correct the problem, drain spa water to appropriate level, if necessary. Make sure there is no standing water under equipment. Reset GFCI. If GFCI immediately trips, the blower may still have moisture in it. It may take up to a few days for the blower to dry sufficiently to be able to reset the GFCI. If, after a few days, the problem persists, contact your spa dealer or Aries Service Department..

Light won't turn on

The light bulb is burned out.

In portable spas, take off the back of the light and change the bulb. Replacement bulbs can be found at most large automotive parts stores, or at Aries. Some inground spas are equipped with swimming pool-type lights, accessible from the front. Contact your spa dealer for bulb replacement instructions.

Water is dripping from plumbing near the equipment area of my spa
"Quick-Coupler" Union has become loose and needs tightening

Your spa has been designed with Quick-Coupler Unions on either side of the equipment so that any necessary servicing can be done easily. Over time, these unions can vibrate loose and start to leak. You can tighten them by turning until hand-tight. If you see a union that has screws, don't try to tighten the screws (They merely hold the two parts of the union together), If you turn the union to tighten and the leak gets worse, try turning the other direction.

I just cleaned my filter and water is dripping from the canister
Water dropped or splashed into the filter area during cleaning has drained down.

Any water that was spilled into the filter cartridge housing during the filter-cleaning process will eventually run down the canister and create the appearance of a leak. This will stop once all spilled water evaporates. No action need be taken on your part, except to make sure that the dripping doesn't continue (see below).

The filter cannister lid wasn't replaced correctly or there are problems with the lid's O-Ring

Make sure to turn off power to the Circulating Pump, then remove filter lid. Check the Filter Lid O-Ring for damage or brittleness. Lubricate or replace if necessary. Make sure the O-Ring is seated properly in the groove of the lid. Replace lid, making sure that it doesn't cross-thread, and tighten sufficiently.

Water in spa is "ugly" or smells bad

Water used to fill the spa was dirty, or water in the piping of the spa was dirty.

It can take your spa a day or two to clear up when initially filled. Make sure your spa is in the "24 Hour" Mode and running continuously. In extreme cases, especially when a spa has been filled with well water, it may be necessary to drain and refill the spa, using filtered water.

Water is not being circulated sufficiently.

Make sure your spa is in the "24 Hour" Mode and running continuously, so that the Ozonator (if so equipped) or chemicals will be properly mixed in the water. We recommend running the Circulating Pump continuously for maximum circulation and filtration.

Filter Cartridge is clogged with body oils or other debris, or filter is damaged

Thoroughly clean the filter, as described in "Cleaning Your Filter". If it still seems heavily embedded, or is damaged, replace it. If the filter is difficult to clean and is over a year old, it is probably time to replace it.

The water has not been chemically treated or there is a chemical imbalance.

See the section on water treatment elsewhere in this manual.

If spa is equipped with Ozone Generator or other non-chemical sanitizer, it is not operating properly.

Make sure the device is plugged in tightly. If it has a fuse, check to see that the fuse has not blown, and replace if necessary.

Verify that a blue light is being omitted from the Ozone Generator. Also, make sure that bubbles are coming from one or both ozone jets located near the light fitting.

Make sure your spa is in the "24 Hour" Mode and running continuously. It is recommended that the Circulating Pump runs continually so that your Ozone Generator can operate round-the-clock.

Algae has grown in the piping system of the spa. Make sure Ozonator (if so equipped) is working properly or that sanitizers are at the proper level. Use Spa Algacide to kill algae and continue to use in maintenance doses to keep it from returning. If necessary, use the Deep Cleaning of Plumbing Lines method in the Maintenance Section of this manual.

ELECTRICAL DIAGRAM FOR ELECTRONIC CONTROLS

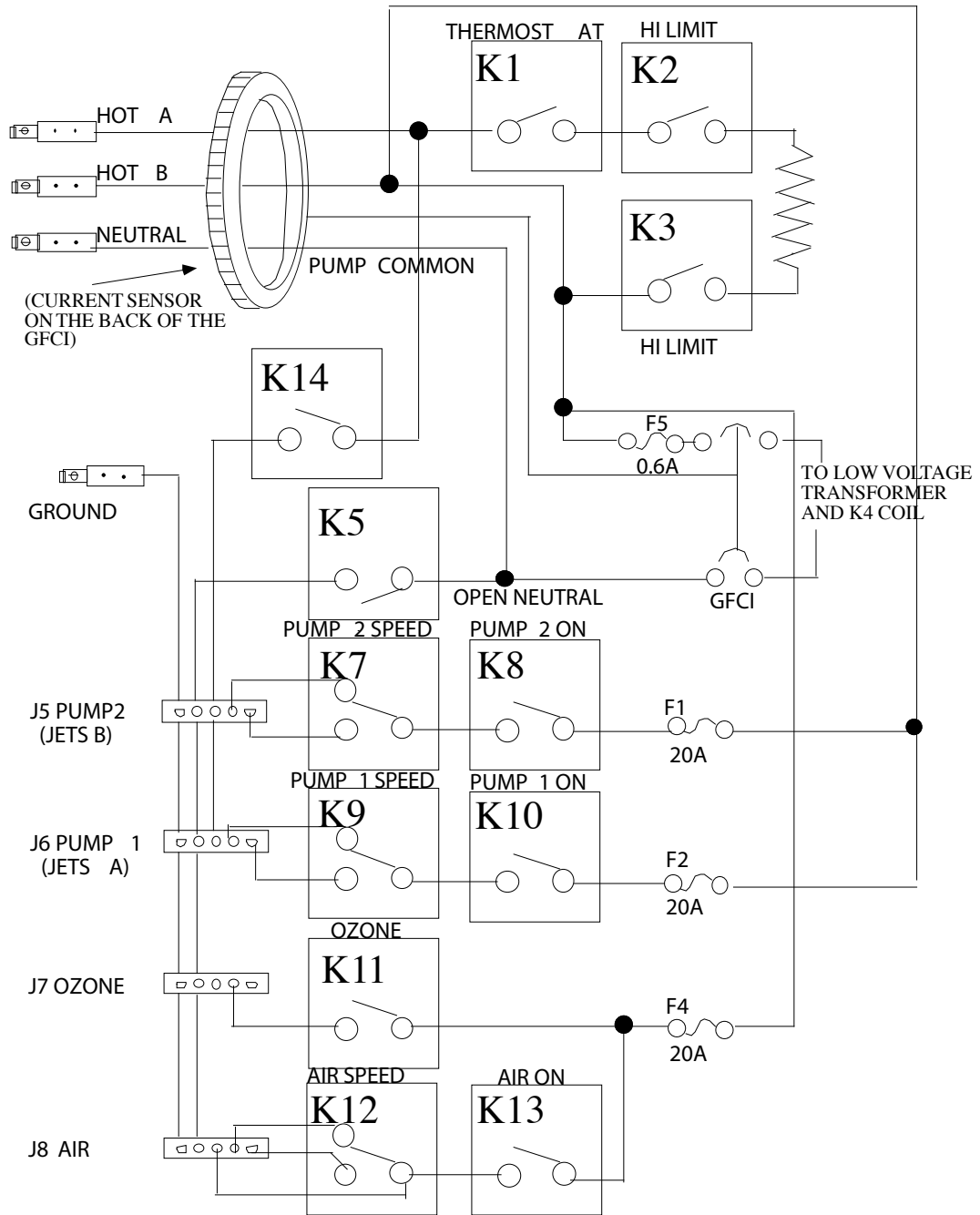

ELECTRICAL CONNECTION FOR ELECTRONIC CONTROLS

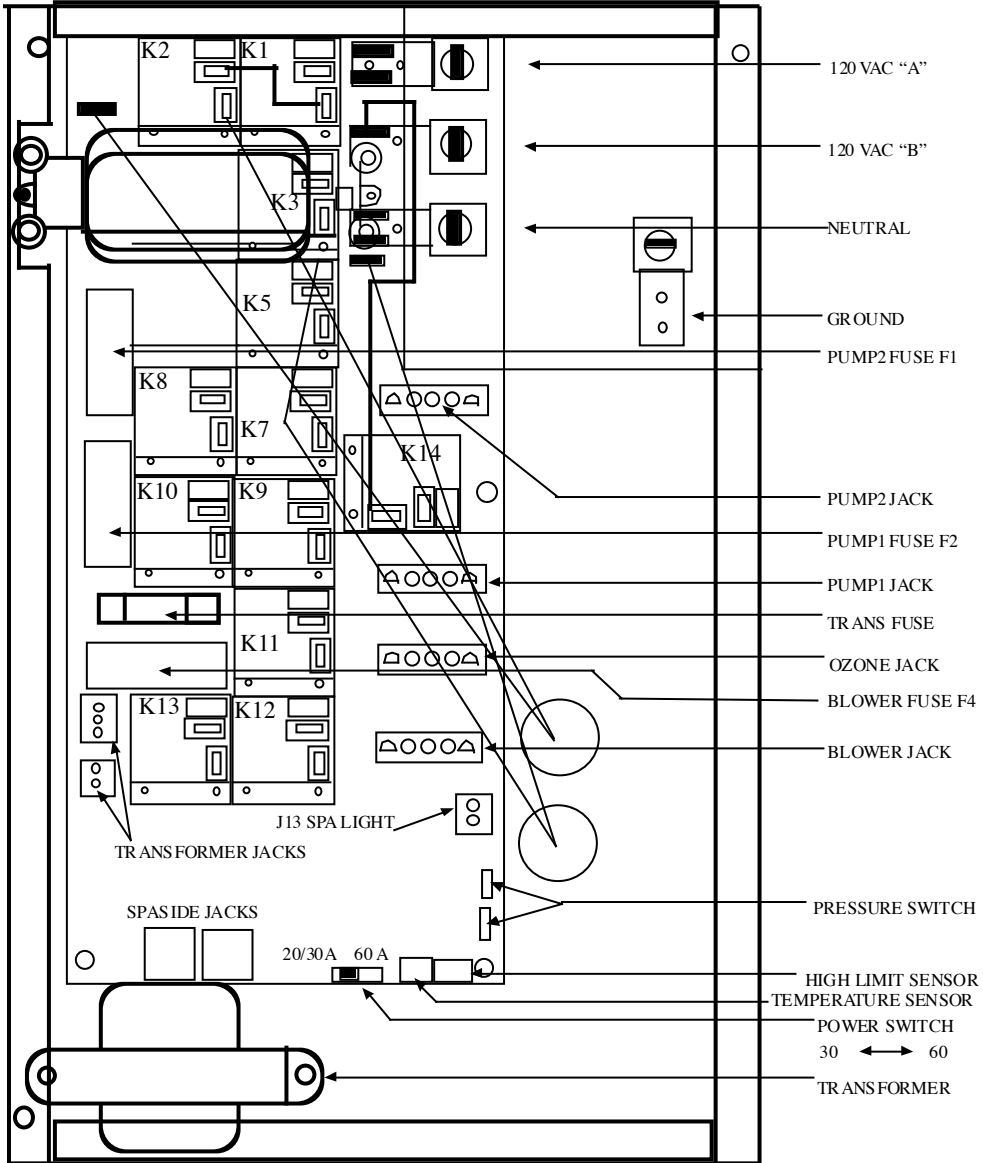

Index

Symbols

12 Hour Mode 10
24 Hour Mode 10

A

Acrylic Surface 24
Adjustment Arrows 7
Adjustment Temperature Readout 7
Air Blower 7, 18
 Malfunctions 29, 30
Air Button 18
Air Control. See Venturi Control
Air Controls 12
Air Injectors 7, 18
Air Light 9
Air Lock 5, 28
Algae 23, 32
Algaecides 23
Auto-Purge System 10

B

Bleed Valve 19, 26
 on Startup 4, 5
Blower 7
 Malfunctions 29, 30
Blower Button 7
Bottom Suction 14, 29
Bottom Suctions 14
Bromine 21

C

Cartridge
 Filter 19, 27, 28, 31
 Cleaning 18, 19, 27, 28, 31
Chlorine 21
Circuit Breaker 26
Circular Jets 15
Circulating Jets 29
Circulating Pump 14, 22, 32

Initial Startup 3
Malfunction 26
Circulation Fittings 13
Circulation Jets 4, 13
Circulation Modes 10
Cleansing 10
Clock 10

D

Digital Controls 6
Digital Temperature Reading 7
Disinfectants 21
Display Inversion 9
Draining Spa 12, 25

E

Electrical Diagram
 Electronic Control 33
 Electrical Connections 34
Electrical Hookup 1, 26

F

Filling spa 3
Filter 18
 Cartridge 19, 27, 28, 31
 Cleaning 18, 19, 27, 28, 31
 Top Loading Pressure 18, 26
Freeze Protection 11, 12
Freezing Temperatures 12
Function Buttons 7

G

GFCI 3, 5, 18, 26, 30
GFCI Reset Button 5, 26, 30
GFCI Test Button 5
Good Night Feature 10
Good Night Function 8

H

Hard water damage 23
Heat Light
 Spa-Side Control 9
High Limit Switch 12
 to reset 12
Hydrotherapy Jets 14

I

Initial Start-up of spa 3
Injectors 7, 18
Interior Fittings 12
Internal Clock 10

J

Jet Pump 13, 14, 28
 Malfunction 28
Jets 13, 14
 Circular 15
 Circulation 4, 13, 29
 Closed 28
 Neck 16, 17
 Recovery 17
 Roto 16
 Standard 15
Jets "A" Light 9
Jets "B" Light 9
Jets Button 8

K

Knife Valve 4, 26, 27, 28

L

L.E.D. Indicator Lights 8
Leaking 30
LED Display Inversion 9
Light 8
 Malfunction 29, 30

Light Button 8
Lights, Indicator 8
Limit Switch 28
Location of Spa 2

M

Massage Jets 13, 14

N

Neck Jets 16, 17
 Water Level at 3

O

Ozone Generator 17, 21, 22, 32

P

pH 21, 22
 Lowering 23
 Raising 23
 With Ozone Generators 22
Placement of Portable Spa 1
Pump, Circulating 22
 Initial Startup 3
 Malfunction 26

Q

Quick Couplers 30

R

Recovery Jets 17
Reset Button 5
RotoJet 16

S

Set Light 9
Setting 12 / 24 Modes 11
Shock Treatment 22
Siphoning Water 25

Skimmer 13, 29
 Water Level at 3, 26
Spa-Side Controls 6
Special Features 9
Staining
 How to prevent 23
Standard Jets 15
Suction Fittings 13, 14
Suctions 29
Surface of Spa 24

T

Temperature Adjustment 6
Temperature Increase/Decrease Arrows
 7
Temperature Readout 7
Temperature Readout/Display Inversion
 9
Test Button 5
Thermostat
 on Spa Side Control 6
 Setting Desired Temperature 7
 Setting During Freezing Temp. 12
Thermostat Setting 26
Top Loading Pressure Filter 18, 26
Top Skimmer 29
Twelve Hour Mode 10
Twenty-Four Hour Mode 10

V

Venturi Controls 12

W

Water
 Smelly or Dirty 31
Water level in Spa 3, 26, 27
Water Treatment 21